

## SG700BT Wireless Handheld Linear Imager Bar code Scanner



# User's Installation and Configuration

## Manual

---

### **Copyright © 2012, Champtek**

This manual is copyrighted, with all rights reserved. Under the copyright laws, this manual may not, in whole or in part, be copied, photocopied, reproduced, translated or converted to any electronic medium or machine readable form without prior written consent of Champtek.

### **Limited Warranty**

Under all circumstances this manual should be read attentively, before installing and/or using the product. In no event shall Champtek be liable for any direct, indirect, special, consequential or incidental damages arising out of the use or inability to use this documentation or product, even if advised of the possibility of such damages. In particular, Champtek shall not be liable for any hardware, software, or data that is stored or used with the product, including the cost of repairing, replacing or recovering the above. Champtek reserves the right to change parts of the device at any time without preceding or direct announcement to the client. Champtek reserves the right to revise this manual, and to make changes in the contents without obligation to notify any person or entity of the revision or change. A serial number appears on the product. Make sure that this official registration number has not been removed. It should be used whenever servicing by Champtek BV or an authorized Champtek dealer is necessary.

**Notice:** The manufacturer shall not be liable for technical or editorial errors or omissions contained herein; nor for incidental or consequential damages in connection with the furnishing, performance or use of the publication

V1.0 Feb. 2012

# Table of contents

---

Table of contents .....	3
INTRODUCTION .....	1
CHAPTER 1 PRODUCT SAFETY.....	2
1.1 Safety & Caution.....	2
1.2 FCC Warning.....	3
CHAPTER 2 GENERAL DESCRIPTION.....	4
2.1 Use of the SG700BT.....	4
CHAPTER 3 INSTALLATION OF THE SG700BT.....	5
3.1 SG700BT Unpacking.....	5
3.2 SG700BT Cradle Installation.....	6
3.3 SG700BT Setup Bluetooth Communication....	7
3.3.1 Pairing.....	7
3.3.2 Setup SPP Master Mode Communication.....	7
3.3.3 Setup SPP Slave Mode Communication.....	9
3.3.4 Setup HID Slave Mode Communication.....	9
3.3.5 Sleep Mode.....	9
3.3.6 Batch Mode.....	10
3.3.7 Out of Range.....	10
CHAPTER 4 CONFIGURING THE SG700BT.....	11
4.1 Preface .....	11
4.1.1 Changing Scanner Settings with Programming Codes 11	
4.1.2 Programming Flow Chart.....	12
4.2 Set All Default Parameter.....	13
4.3 General Process .....	13

4.3.1	Abort Configuration .....	14
4.3.2	Recall .....	14
4.3.3	Version Information .....	14
4.4	Cradle Interface Selection.....	14
4.4.1	Interface .....	14
4.5	Bluetooth Scanner Setup.....	15
4.5.1	Preface .....	15
4.5.2	Scanner Mode .....	15
4.5.3	*** Batch Mode ("***" means "Quick Setting Label", The function can be executed directly by scanning barcode instead of doing the general process.) .....	16
4.5.4	Out of Range .....	16
4.5.5	Sleep Mode .....	16
4.6	Scanner Operation.....	17
4.6.1	Reading Mode .....	17
4.6.2	Beeper Option .....	18
4.6.3	Reading Level .....	18
4.6.4	Accuracy Scan .....	18
4.6.5	Sensitivity of Continuous Reading .....	19
4.6.6	Same Code Delay Reading Interval .....	19
4.6.7	Reverse Output Characters .....	20
4.7	RS232 Mode Parameters.....	20
4.7.1	Baud Rate .....	20
4.7.2	Data/Stop Bits .....	21
4.7.3	Parity .....	21
4.7.4	Handshaking .....	22
4.8	Keyboard Wedge Mode Parameters.....	24
4.8.1	Terminal Type .....	24

4.8.2	Country/Language	25
4.8.3	Upper/Lower Case	26
4.8.4	Capslock Detection	26
4.8.5	Character by ALT Method	27
4.8.6	Select Numerical Pad	27
4.8.7	Interscan Code Delay	27
4.9	Output Characters	28
4.9.1	Select Terminator	28
4.10	Code Type	29
4.10.1	Barcode Selection	29
4.11	UPC/EAN/JAN Parameters	32
4.11.1	Reading Type	32
4.11.2	Supplemental Setup	34
4.11.3	Check Digit Transmission	34
4.12	Code 39 Parameters	35
4.12.1	Type of Code	35
4.12.2	Check Digit Transmission	35
4.12.3	Output Start/Stop Character	36
4.12.4	Decode Asterisk	36
4.12.5	Setup Code Length	36
4.13	Code 128 Parameters	38
4.13.1	Reading Type	38
4.13.2	Check Digit Transmission	39
4.13.3	Append FNC2	39
4.13.4	Setup Code Length	39
4.14	Interleave 2 of 5 Parameters	41
4.14.1	Check Digit Transmission	41
4.14.2	Setup Number of Character	41

4.14.3	Brazilian Banking Code .....	41
4.14.4	Setup Code Length .....	42
4.15	Industrial 2 of 5 Parameters.....	43
4.15.1	Reading Type .....	43
4.15.2	Check Digit Transmission .....	43
4.15.3	Setup Code Length .....	44
4.16	Matrix 2 of 5 Parameters.....	45
4.16.1	Check Digit Transmission .....	45
4.16.2	Setup Code Length .....	46
4.17	CODABAR/NW7 Parameters.....	47
4.17.1	Setup Start/Stop Characters upon Transmission.....	47
4.17.2	Transmission Type of Start/Stop .....	47
4.17.3	Setup Code Length .....	48
4.18	Code 93 Parameters.....	50
4.18.1	Check Digit Transmission .....	50
4.18.2	Setup Code Length .....	50
4.19	Code 11 Parameters.....	52
4.19.1	Check Digit Transmission .....	52
4.19.2	Setup Code Length .....	52
4.20	MSI/Plessey Code Parameters.....	54
4.20.1	Check Digit Transmission .....	54
4.20.2	Setup Code Length .....	54
4.21	Telepen Parameters.....	56
4.21.1	Type of Code .....	56
4.21.2	Check Digit Transmission .....	56
4.21.3	Setup Code Length .....	56
4.22	GS1 Databar Omnidirectional Parameters...	58
4.22.1	Check Digit Transmission .....	58

4.22.2	Application ID.....	58
4.22.3	Symbology ID.....	58
4.23	GS1 Databar Limited Parameters.....	59
4.23.1	Check Digit Transmission.....	59
4.23.2	Application ID.....	59
4.23.3	Symbology ID.....	59
4.24	GS1 Databar Expanded Parameters.....	60
4.24.1	Symbology ID.....	60
CHAPTER 5	MISCELLANEOUS PARAMETERS.....	61
5.1	Bar Code ID.....	61
5.1.1	Default Barcode ID.....	61
5.1.2	User Define Code ID.....	62
5.2	Preamble and Postamble Insertion.....	64
5.2.1	Setup Insertion.....	64
5.2.2	Insertion Set Number.....	65
5.2.3	Code Type for Insertion.....	66
5.2.4	Position to Be Inserted.....	68
5.2.5	Characters to Be Inserted.....	68
5.3	Character Deletion.....	68
5.3.1	Deletion Set Number.....	70
5.3.2	Code Type for Deletion.....	70
5.3.3	Position to Be Deleted.....	72
5.3.4	Number of Characters to Be Deleted.....	72
APPENDIXES	.....	73
A.	Decimal Value Table.....	73
B.	ASCII Value Table.....	74
C.	ASCII Table.....	75
D.	Function Key Table.....	81

E.	Technical Specifications.....	82
F.	Scan Map.....	84
G.	LED Indicator Status.....	85
H.	Test Symbologies.....	86
	Quick Configuration.....	88



## **INTRODUCTION**

---

**SG700BT** is a gun-type barcode scanner which is designed specifically for retail market. To the brand new series of SG700BT, we add on more user-friendly functions with detachable interface cable that makes it easier to be operated by the customers.

Speaking of the performance, this scanner supports middle to long range mode. SG700BT which supports the reading depth up to 50 centimeters, and the scan speed is up to 500 scans per second.

In short, SG700BT is absolutely a high performance gun-type scanner which provides the customer with the most cost-effective solution in the market. It is perfectly suitable and definitely the best choice for any retailers using POS environment.

The SG700BT is available in various interface types, RS232, Keyboard Wedge, USB HID or Virtual comport interface, so there is always a solution to connect the SG700BT to your POS system.

# CHAPTER 1 PRODUCT SAFETY

---

## 1.1 Safety & Caution

1. Please read the following safety statement carefully.
2. Please preserve this user's manual for reference sometime.
3. Before cleaning the SG700BT, the users must cut off all AC power. Do not use liquid or spray type of detergent to clean the SG700BT. Please use dampish cotton cloth to clean the SG700BT.
4. The outlet must set nearby the SG700BT for connecting power easily.
5. Keep the SG700BT dry to avoid short circuit.
6. During installation you must fix the equipment at solid table to avoid damage caused by falling.
7. Before inserting power please ensure the voltage is healthy to the equipment.
8. For safety please tie wire well and don't put anything on the wire.
9. If you don't use this equipment for long time, please cut off the power to avoid damage from surge power.
10. Don't spray any liquid on this scanner because it may cause a fire or short circuit.
11. Please do not open the equipment. For safety only the qualified serviceman can open the equipment.
12. If there are the following situations please contact the qualified serviceman to check this equipment.
  - (a) The damage of wire or pin of power supply.
  - (b) Some Liquid infiltrate into the equipment.
  - (c) The equipment has been exposed to wet environment.
  - (d) The equipment can't work well.
  - (e) The equipment has any obvious damage, making the SG700BT working abnormally.
13. Don't store the SG700BT at the temperature lower than  $-20^{\circ}\text{C}$  ( $-4^{\circ}\text{F}$ ) or higher than  $+70^{\circ}\text{C}$  ( $158^{\circ}\text{F}$ ) to avoid any damage.

## 1.2 FCC Warning

This equipment complies with the requirements in Part 15 of FCC.

Any operation must comply with the conditions below:

- (a) The equipment will not cause any severe interference.
- (b) The equipment can avoid any interference from environment.

### **Warning!**



*Statement:*

*This product is classified as B class product. In environment this product may cause some interference. In this situation the user may do something to avoid interference.*

## **CHAPTER 2 GENERAL DESCRIPTION**

---

### **2.1 Use of the SG700BT**

The SG700BT is very ergonomic and modern designed and very user friendly. It can be connected to your POS or Host system trough a RS232, Keyboard Wedge or USB cable.

To read a bar code, simply press the red trigger button and aim the beam to the bar code. It needs to position the beam to fall across all bars in the 1D barcodes. You will hear one beep and the green LED indicator will light on after scan successfully.

The programming of the SG700BT is very easy. You can setup the SG700BT by scan all necessary programming codes that meet applications. Thanks to the powerful decoding software, the SG700BT can decode all major 1D codes.

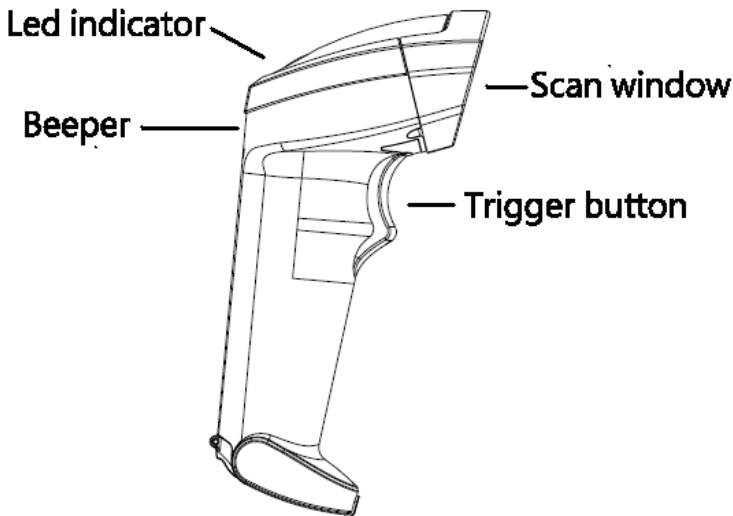

## **CHAPTER 3 INSTALLATION OF THE SG700BT**

---

### **3.1 SG700BT Unpacking**

Unpack the SG700BT as follows:

1. Take the SG700BT and its accessories out of the box.
2. Remove the packing material.
3. Check the packing list to make sure you have received all of the items ordered.

#### **3.1 Standard Shipment Package:**

- a. SG700BT Linear Barcode Scanner
- b. Bluetooth Cradle
- c. Communication Cable (RS-232, keyboard wedge or USB)
- d. Power Adaptor
- e. Product Compact Disc

#### **3.2 Scanner only shipment package:**

- a. SG700BT Linear Barcode Scanner
  - b. Battery Charger
  - c. Product Compact Disc
4. Visually inspect the SG700BT and accessories for any evidence of physical damage.
  5. If anything is missing or appears to be damaged, immediately contact your dealer.

#### **ATTENTION**

Store the packing material and boxes: it should be used whenever the SG700BT is transported for service.

### 3.2 SG700BT Cradle Installation

To setup your SG700BT scanner with Bluetooth technology, please follow the steps.

1. Connect the supplied communication cable at the bottom side of the cradle.
2. Connect the other side of the communication cable to the right connector of your POS or HOST system.
3. Plug the external power supply into the power jack on the bottom of the cradle.
4. Plug the power supply into the AC outlet.
5. Turn on your POS or HOST system.

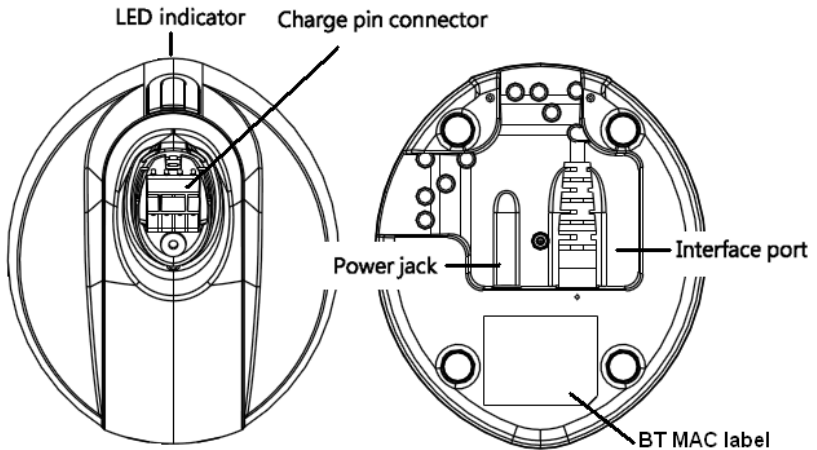

## 3.3 SG700BT Setup Bluetooth Communication

### 3.3.1 Pairing

Pairing refers to when a SG700BT scanner has been linked or paired to a specific cradle by scanning that cradle's **Bluetooth MAC address code**. This Bluetooth MAC address code is unique for each cradle. This address code is located on the bottom side of the cradle. The pairing of a SG700BT scanner to a cradle is one to one. Only one SG700BT scanner can be paired to a cradle at any point in time.

### 3.3.2 Setup SPP Master Mode Communication

To setup the communication between the SG700BT scanner and the cradle, follow the steps:

1. The SG700BT scanner must scan "SPP Master Mode" barcode to set the SG700BT scanner in Master mode.
2. Scan the **Bluetooth MAC address code** located on the bottom of the cradle.
3. When the Bluetooth MAC was successfully scanned, scanner will initiate with 3 short beep sounds. Blue LED will blink followed by a long beep sound.
4. Wait approximately five seconds, for completing the connection process. Blue LED will slow flash on scanner for connecting the cradle.
5. If successful, the blue LED on the cradle will be on.
6. If the connections failed, the blue LED on scanner will be off, and the cradle indicators blinking blue LED.

## ATTENTION

The *SG700BT* scanner must be charged for a minimum of 8 hours before the scanner can be placed in full operation for the first time. The scanner LED will indicate in red when the scanner is charged.

After the battery is full, the green LED on scanner will be on. The charge green LED will be off when the scanner leaving from cradle. If the battery power of the *SG700BT* is too low, the *SG700BT* will indicate red LED and beeper warning.

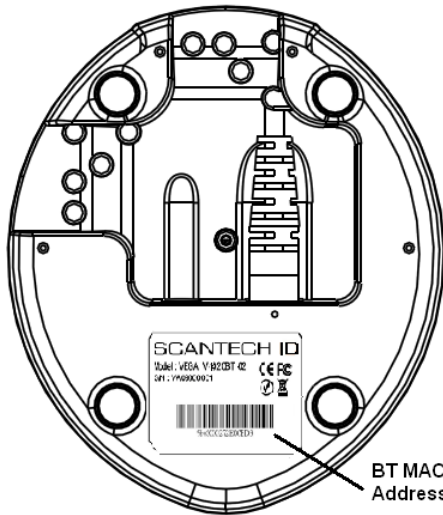

It is important to know that the *SG700BT* scanner will only communicate with the cradle whose unique Bluetooth MAC address was last scanned.

If a cradle is paired with the *SG700BT* scanner, another *SG700BT* scanner can't be paired with that cradle until the original connection is interrupted.

If you pair a second *SG700BT* scanner to an in-use cradle, the cradle's connection to the first *SG700BT* scanner will be interrupted and the connection will be re-established with the second *SG700BT* scanner.



### **3.3.3 Setup SPP Slave Mode Communication**

To setup the communication between the SG700BT scanner and Bluetooth SPP profile application device, follow the steps.

1. The SG700BT scanner must scan "SPP Slave Mode" barcode, to set the SG700BT scanner in Slave mode.
2. When control the Bluetooth device to search the scanner, enter pin code (default 00:00:00) to setup comport.
3. When SG700BT scanner is successful connected, the scanner Blue LED will also blink followed by a long beep sound. Blue LED will slow flash to finish the setup.

### **3.3.4 Setup HID Slave Mode Communication**

To setup the communication between the SG700BT scanner and Bluetooth HID profile application device, follow the steps.

1. The SG700BT scanner must scan "HID Slave Mode" barcode, to set the SG700BT scanner in HID Slave mode.
2. When control the Bluetooth device to search the scanner, enter pin code to setup pair. You can scan number barcode on Appendix B."ASCII VALUE TABLE" number 0~9 to setup.
3. When SG700BT scanner is successful connected, scanner Blue LED will also blink followed by a long beep sound. Blue LED will slow flash to finish the setup.

### **3.3.5 Sleep Mode**

The SG700BT scanner enters sleep mode to save battery energy, when the SG700BT scanner is used for 1 minute or 10 minute time. During sleep mode all the functions and connection will be halted. After press the red trigger button the scanner will wake up and reconnect the communication with the cradle or Bluetooth device.

### **3.3.6 Batch Mode**

This batch mode is enabled when you have scanned "Batch Mode on". The scanned data is stored in the memory of the SG700BT scanner instead of being transmitted. You can delete the last scanned bar code data by scanning "Delete Last Data" bar code. This function is disabled when you scan "Batch Mode OFF".

When scan bar code "Batch Data Output", the stored scanned data will be immediately transmitted to the host. When scan barcode "Batch Data Clear", all stored scanned data will be erased from memory.

The capacity of this memory depends on the scanned data. The memory size is approximately 30,000 sets of EAN13 bar code type.

### **3.3.7 Out of Range**

When "Out of Range" function is enabled, and the scanner is working at out of transmission range, the scanned data will be stored to out-of-range memory. Memory size is approximately 25,000 sets of EAN13 bar code type.

The all stored data will send back to device when the link is reconnected, and the all data store in out-of-range memory will be cleared.

## **CHAPTER 4 CONFIGURING THE SG700BT**

---

### **4.1 Preface**

How to configure the SG700BT?

The barcode programming feature gives the possibility to change the SG700BT scanner settings with programming labels.

#### **4.1.1 Changing Scanner Settings with Programming Codes**

You can setup your SG700BT by scan all necessary programming codes that meet applications.

In order to change the scanner settings please follow the sequence below:

1. Power up the scanner.
2. Open the scanner programming mode by scanning "Start Configuration".
3. Change scanner settings by scanning any of the programming code that meet applications.
4. Close the scanner programming mode by scanning "End Configuration".
5. Save configuration by scanning "Save Parameters".

An Example:

For changing the Baud rate to 38400 the following codes must be scanned successively:

Start Configuration→Baud Rate 38400→End configuration→  
Save Parameters

After reading a valid programming code the scanner, will give three high beep and the green LED indicator will light on.

By scanning "Set All Default" label, the settings will go back to the factory default settings.

#### 4.1.2 Programming Flow Chart

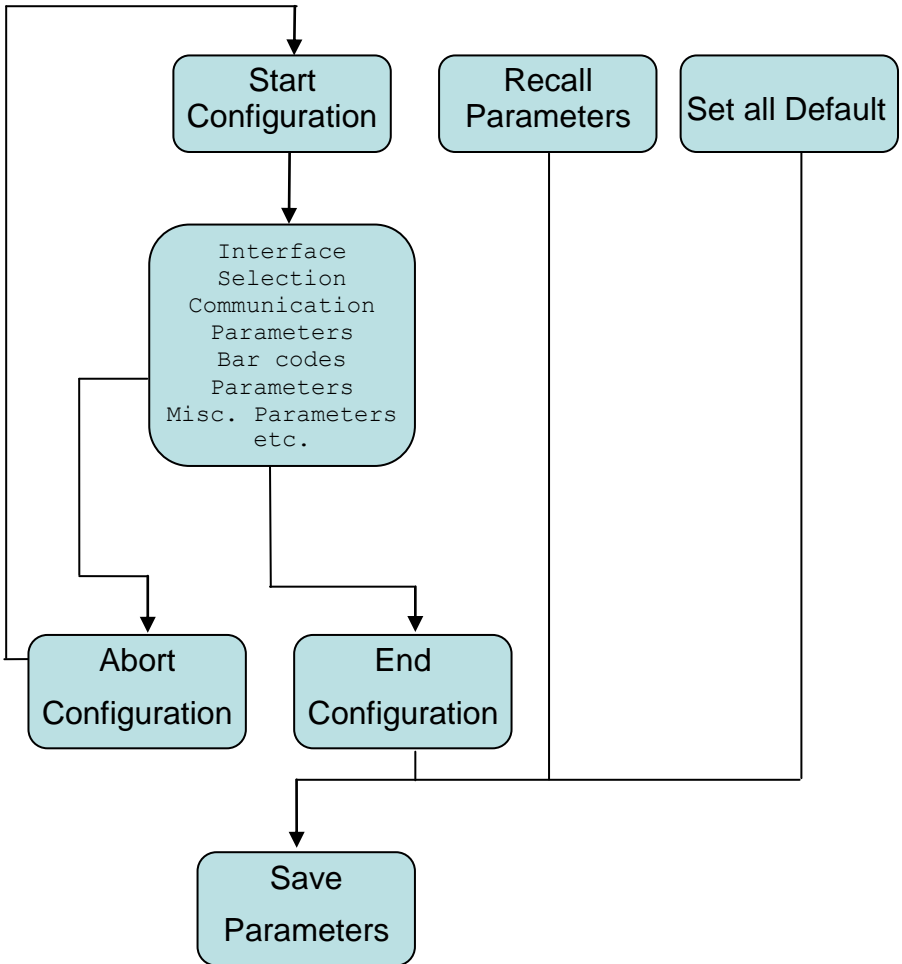

## 4.2 Set All Default Parameter

By scanning "Set All Default" label, the all parameters will go back to the factory default settings for scanner and cradle.

After reading a valid programming code the scanner will give a three high beep and the Green LED indicator will light on.

---

Set all the parameters to the  
factory default settings



---

## 4.3 General Process

---

1 Power up the Scanner

---

2 Scan the Start Configuration bar  
code



---

3 Scan the bar code for the desired feature.

---

4 Scan End of Configuration bar code



---

5 Scan Save Parameters bar code



### 4.3.1 Abort Configuration

---

Terminate current programming status.



### 4.3.2 Recall

---

Replace the current parameters by the parameters saved last time



### 4.3.3 Version Information

---

Display the Scanner version information and date code



Display the Cradle version information and date code



Display the Scanner Bluetooth MAC Address



Display the Cradle Bluetooth MAC Address



## 4.4 CRADLE Interface Selection

---

### 4.4.1 Interface

---

Keyboard Mode



---

RS232 Mode



---

<USB HID Mode>



---

USB Virtual Comport Mode



---

## 4.5 Bluetooth Scanner Setup

### 4.5.1 Preface

How to configure the Bluetooth function:

The barcode programming feature gives the possibility to change the SG700BT scanner settings with programming labels.

### 4.5.2 Scanner Mode

---

BT Parameter set default



---

SPP Master Mode



---

SPP Slave Mode



---

HID Slave Mode



**4.5.3 \*\*\* Batch Mode** (“\*\*\*” means “Quick Setting Label”, The function can be executed directly by scanning barcode instead of doing the general process.)

---

Batch Mode ON



---

<Batch Mode OFF>



---

\*\*\*Batch Data Output



---

\*\*\*Batch Data Clear



---

\*\*\*Delete Last Data



---

#### 4.5.4 Out of Range

---

<Out of Range Enable>



---

Out of Range Disable



---

#### 4.5.5 Sleep Mode

---

Sleep Mode On 1 minute





---

Sleep Mode On 10 minute



---

<Sleep Mode OFF>



---

## 4.6 Scanner Operation

### 4.6.1 Reading Mode

---

<Good Read OFF>



---

Trigger ON/OFF



---

Continuous/Trigger OFF



---

Continuous/Auto Power ON



---

Flash



---

Flash/Auto Power ON



---



Auto Sence





### 4.6.2 Beeper Option

<High>	
Medium	
Low	
Off	

### 4.6.3 Reading Level

Bar Equals High	
<Bar Equals Low>	

### 4.6.4 Accuracy Scan

< Require 1 good decoding for a good scan>	
Require 2 consecutive decoding of the same bar code data for a good scan	
Require 3 consecutive decoding of the same bar code data for a good scan	

---

Require 4 consecutive decoding of the same bar code data for a good scan

---



#### 4.6.5 Sensitivity of Continuous Reading

This feature is working under Reading Continuous Mode.

---

<Fast>



Slow



#### 4.6.6 Same Code Delay Reading Interval

Following code sequences represent the length of time before a barcode can be rescanned at continuous and flash reading mode. The value can be defined from 1-50 and they represent 100ms to 5 seconds in 100ms interval. Default value is 3(0.3 second).

**To setup same code Delay reading interval:**

1. Scan the "Begin" label
2. Go the Decimal Value Tables in Appendix B, Scan label(s), that represents the same code delay reading interval. They are ranged from 1-50. One step is represented 0.1 second. So the interval is from 0.1 to 5 seconds.

3. Scan the "Complete" label

Repeat the steps 1-3 to set time out of same symbol

---

1. Begin



---

2. Decimal Value (1-50) (Appendix A)

---

3.Complete



### 4.6.7 Reverse Output Characters

Example: 012345 → 543210

---

Enable



<Disable>



## 4.7 RS232 Mode Parameters

### 4.7.1 Baud Rate

1200



2400



4800



<9600>



---

19200



---

38400



---

57600

---



### 4.7.2 Data/Stop Bits

The number of data/stop bits transmitted for each character

---

7 Data Bits



---

< 8 Data Bits >



---

< 1 Stop Bits >



---

2 Stop Bits

---



### 4.7.3 Parity

A Parity bit is an extra data bit used to check data transmission errors.

---

<None>



---

Even – Select to set the parity bit either 1 or 0 to ensure the number of 1.



---

Odd – Select to set the parity bit either a 1 or 0 to ensure the number of 1.



---

Mark – Select to set the parity bit always 1.



---

Space– Select to set the parity bit always 0.

---



#### 4.7.4 Handshaking

---

RTS/CTS ON – Output a Request to Send (RTS) signal and wait for a Clear to Send (CTS) signal before transmitting data



---

**<RTS/CTS OFF>**



---

ACK/NAK ON – After transmitting data, wait for host to send an ACK or a NAK response. If ACK is received, then complete the data transmission. If NAK is received, re-send the last set of data and wait for ACK/NAK again.



---

**<ACK/NAK OFF>**

---



---

XON/XOFF ON - After transmitting data, wait for host to send an XON or a XOFF response. If XON is received, then complete the data transmission. If XOFF is received, stop the transmission.

---











**<XON/XOFF OFF>**

---













## 4.8 Keyboard Wedge Mode Parameters

### 4.8.1 Terminal Type

<b>&lt;IBM PC/AT,PS/2&gt;</b> - Includes IBM PS/2 and compatible models 50, 55, 60, 80	
IBM PC/XT	
IBM PS/2 25, 30	
IBM 5550	
IBM 102 Key	
IBM 122 Key (1)	
IBM 122 Key (2)	
NEC 9800	
Apple Desktop Bus (ADB)	





## 4.8.2 Country/Language

<b>&lt;US English&gt;</b>	
UK English	
Italian	
Spanish	
French	
German	
Swedish	
Switzerland	
Hungarian	
Japanese	
Belgium	

Portuguese	
Denmark	
Netherlands	
Turkey	

#### 4.8.3 Upper/Lower Case

<b>&lt;No Change&gt;</b>	
Enable Lower Case - Transmit all data as lower case	
Enable Upper Case - Transmit all data as upper case	

#### 4.8.4 Capslock Detection

Enable	
<b>&lt;Disable&gt;</b>	

### 4.8.5 Character by ALT Method

---

ALT Method Enable



---

<ALT Method Disable>



### 4.8.6 Select Numerical Pad

---

Numerical Pad ON



---

<Numerical Pad OFF>



### 4.8.7 Interscan Code Delay

---

<No Delay>



---

5 ms



---

10 ms



---



25 ms



---

50 ms



100 ms	
200 ms	
300 ms	
<b>4.9 Output Characters</b>	
<b>4.9.1 Select Terminator</b>	
<b>&lt;CR+LF&gt;</b> - The scanner transmits a carriage return and a line feed after each scan	
CR Suffix - The scanner transmits a carriage return after each scan	
LF Suffix - The scanner transmits a line feed after each scan	
Space	
Tab	
STX-ETX - RS232 only	
None	

## 4.10 Code Type

### 4.10.1 Barcode Selection

If "All Bar Code ON" is selected, the scanner could read all types of bar code. If "Disable" is selected for a certain bar code type, the scanner could not read the particular bar code. The symbol of "<>" means default setting.

---

All Bar Codes ON



---

<UPC-A ON>



---

UPC-A OFF



---

<UPC-E ON>



---

UPC-E OFF



---

<EAN-13 / JAN-13 ON>



---

EAN-13 / JAN-13 OFF



---

<EAN-8 / JAN-8 ON>



---

EAN-8 / JAN-8 OFF



---

**<CODE 39 ON>**



---

CODE 39 OFF



---

Code32 / Italian Pharmacy ON



---

**<Code32 / Italian Pharmacy OFF>**



---

**<Code 128 ON>**



---

Code 128 OFF



---

**<Interleave 2 of 5 ON>**



---

Interleave 2 of 5 OFF



---

**<Codabar/NW7 ON>**



---

Codabar/NW7 OFF



---

Industrial 2 of 5 ON



---

**<Industrial 2 of 5 OFF>**



---

Matrix 2 of 5 ON



---

**<Matrix 2 of 5 OFF>**



---

CODE 93 ON



---

**<CODE 93 OFF>**



---

CODE 11 ON



---

**<CODE 11 OFF>**



---

MSI/PLESSEY ON



---

**<MSI/PLESSEY OFF>**



---

Telepen ON



---

**<Telepen OFF>**



---

China Postage ON



---

**<China Postage OFF>**



---

GS1 DataBar Omnidirectional ON



---

**<GS1 DataBar Omnidirectional OFF>**



---

GS1 DataBar Expanded ON



---

**<GS1 DataBar Expanded OFF>**



---

GS1 DataBar Limited ON



---

**<GS1 DataBar Limited OFF>**



---

## 4.11 UPC/EAN/JAN Parameters

### 4.11.1 Reading Type

---

UPC-A=EAN-13 ON  
Add 0 before UPC-A to make it 13  
digits.



---

**<UPC-A = EAN-13 OFF>**



---

ISBN Enable





---

**<ISBN Disable>**





ISSN Enable	
<b>&lt;ISSN Disable&gt;</b>	
Decode with Supplement	
<b>&lt;Auto Discriminate Supplement&gt;</b>	
Expand UPC-E Enable	
<b>&lt;Expand UPC-E Disable&gt;</b>	
EAN8=EAN13 Enable	
<b>&lt;EAN8=EAN13 Disable&gt;</b>	
GTIN Format Enable	
<b>&lt;GTIN Format Disable&gt;</b>	

### 4.11.2 Supplemental Setup



---

<Not Transmit>	
2 Digit Supplemental	
5 Digit Supplemental	
2 & 5 Digit Supplemental	

---

### 4.11.3 Check Digit Transmission

---

<UPC-A Check Digit Transmission ON>	
UPC-A Check Digit Transmission OFF	
<UPC-E Check Digit Transmission ON>	
UPC-E Check Digit Transmission OFF	
<EAN-8 Check Digit Transmission ON>	
EAN-8 Check Digit Transmission OFF	

---

---

**<EAN-13 Check Digit Transmission  
ON>**



---

EAN-13 Check Digit Transmission OFF



---

**<ISSN Check Digit Transmission ON>**



---

ISSN Check Digit Transmission OFF



---

## **4.12 Code 39 Parameters**

### **4.12.1 Type of Code**

---

**<Standard Code 39>**



---

Full ASCII Code 39



---

**<Italian Pharmacy/Code 32 Off>**



---

Italian Pharmacy/Code 32 ON



---

### **4.12.2 Check Digit Transmission**

---

**<Do Not Calculate Check Digit>**



---

Calculate Check Digit and Transmit



---

Calculate Check Digit and Not  
Transmit



---

### 4.12.3 Output Start/Stop Character

---

Enable



---

<Disable>



---

### 4.12.4 Decode Asterisk

---

Enable



---

<Disable>



---

### 4.12.5 Setup Code Length

To set the fixed length: (2 sets available)

1. Scan the "Begin" programming code of the desired set.
2. Go to the Decimal Value Table in Appendix A. Scan programming codes that represent the length to be read.
3. Scan the "Complete" programming code of the desired set.

Repeat the steps 1 - 3 to set additional code length.

---

<Variable>



---

**Fixed Length 1<sup>st</sup> Set**

---

1<sup>st</sup> Set Begin



---

Decimal Value

See Appendix A

---

1<sup>st</sup> Set Complete



---

**Fixed Length 2<sup>nd</sup> Set**

---

2<sup>nd</sup> Set Begin



---

Decimal Value

See Appendix A

---

2<sup>nd</sup> Set Complete



---

**Minimum Length**

---

Minimum Length Begin



---

Decimal Value

See Appendix A

---

Minimum Length Complete



## **4.13 Code 128 Parameters**

### **4.13.1 Reading Type**

---

UCC/EAN-128 Enable



<UCC/EAN-128 Disable>



<Enable `]C1' Code Format>



Disable `]C1' Code Format



<Enable Code128 Group Separators  
(GS)>



Disable Code128 Group Separators  
(GS)



### 4.13.2 Check Digit Transmission

---

Do Not Calculate Check Digit



---

Calculate Check Digit and Transmit



---

<Calculate Check Digit and Not  
Transmit>



---

### 4.13.3 Append FNC2

---

ON



---

<OFF>



---

### 4.13.4 Setup Code Length

To set the fixed length: (2 sets available)

1. Scan the "Begin" programming code of the desired set
2. Go to the Decimal Value Table in Appendix A. Scan programming codes that represent the length to be read.
3. Scan the "Complete" programming code of the desired set.

Repeat the steps 1 - 3 to set additional length.

---

<Variable>



**Fixed Length 1<sup>st</sup> Set**

---

1 <sup>st</sup> Set Begin	
Decimal Value	See Appendix A
1 <sup>st</sup> Set Complete	

---

**Fixed Length 2<sup>nd</sup> Set**



---

2 <sup>nd</sup> Set Begin	
Decimal Value	See Appendix A
2 <sup>nd</sup> Set Complete	

---

**Minimum Length**

---

Minimum Length Begin	
Decimal Value	See Appendix A
Minimum Length Complete	

---



## 4.14 Interleave 2 of 5 Parameters

### 4.14.1 Check Digit Transmission

---

<Do Not Calculate Check Digit>



---

Calculate Check Digit and Transmit



---

Calculate Check Digit and Not  
Transmit



### 4.14.2 Setup Number of Character

---

<Even>



---

Odd



### 4.14.3 Brazilian Banking Code

---

Enable



---

<Disable>



#### 4.14.4 Setup Code Length

To set the fixed length: (2 sets available)

1. Scan the "Begin" programming code of the desired set
2. Go to the Decimal Value Table in Appendix A. Scan programming codes that represent the length to be read.
3. Scan the "Complete" programming code of the desired set.

Repeat the steps 1 - 3 to set additional length.

---

<Variable>



---

#### Fixed Length 1<sup>st</sup> Set

---

1<sup>st</sup> Set Begin



---

Decimal Value

See Appendix A

---

1<sup>st</sup> Set Complete



---

#### Fixed Length 2<sup>nd</sup> Set

---

2<sup>nd</sup> Set Begin



---

Decimal Value

See Appendix A

---

---

2<sup>nd</sup> Set Complete



---

**Minimum Length**

---

Minimum Length Begin



---

Decimal Value

See Appendix A

---

Minimum Length Complete



---

**4.15 Industrial 2 of 5 Parameters**

**4.15.1 Reading Type**

---

IATA25 Enable



---

<IATA25 Disable>



---

**4.15.2 Check Digit Transmission**

---

<Do Not Calculate Check Digit>



---

Calculate Check Digit and Transmit



---

Calculate Check Digit and Not  
Transmit



---

### 4.15.3 Setup Code Length

To set the fixed length: (2 sets available)

1. Scan the "Begin" programming code of the desired set
2. Go to the Decimal Value Table in Appendix A. Scan programming codes that represent the length to be read.
3. Scan the "Complete" programming code of the desired set.

Repeat the steps 1 - 3 to set additional length.

---

<Variable>



---

#### Fixed Length 1st Set

---

1<sup>st</sup> Set Begin



---

Decimal Value

See Appendix A

---

1<sup>st</sup> Set Complete



---

#### Fixed Length 2<sup>nd</sup> Set

---

2<sup>nd</sup> Set Begin



---

Decimal Value

See Appendix A

---

2<sup>nd</sup> Set Complete



**Minimum Length**

---

Minimum Length Begin



Decimal Value

See Appendix A

---

Minimum Length Complete



**4.16 Matrix 2 of 5 Parameters**

**4.16.1 Check Digit Transmission**

---

<Do Not Calculate Check Digit>



Calculate Check Digit and Transmit



Calculate Check Digit and Not  
Transmit



## 4.16.2 Setup Code Length

To set the fixed length: (2 sets available)

1. Scan the "Begin" programming code of the desired set
2. Go to the Decimal Value Table in Appendix A. Scan programming codes that represent the length to be read.
3. Scan the "Complete" programming code of the desired set.

Repeat the steps 1 - 3 to set additional length.

---

<Variable>



---

### Fixed Length 1<sup>st</sup> Set

---

1<sup>st</sup> Set Begin



---

Decimal Value

See Appendix A

---

1<sup>st</sup> Set Complete



---

### Fixed Length 2<sup>nd</sup> Set

---

2<sup>nd</sup> Set Begin



---

Decimal Value

See Appendix A

---

---

2<sup>nd</sup> Set Complete



---

**Minimum Length**

---

Minimum Length Begin



---

Decimal Value

See Appendix A

---

Minimum Length Complete



---

**4.17 CODABAR/NW7 Parameters**

**4.17.1 Setup Start/Stop Characters upon  
Transmission**

---

ON



---

<OFF>



---

**4.17.2 Transmission Type of Start/Stop**

---









A/B/C/D <Start>



---

A/B/C/D <Stop>



A Start	
A Stop	
B Start	
B Stop	
C Start	
C Stop	
D Start	
D Stop	

### 4.17.3 Setup Code Length

To set the fixed length: (2 sets available)

1. Scan the "Begin" programming code of the desired set
2. Go to the Decimal Value Table in Appendix A. Scan programming codes that represent the length to be read.
3. Scan the "Complete" programming code of the desired set.

Repeat the steps 1 - 3 to set additional length.



---

<Variable>



---

**Fixed Length 1<sup>st</sup> Set**

---

1<sup>st</sup> Set Begin



---

Decimal Value

See Appendix A

---

1<sup>st</sup> Set Complete



---

**Fixed Length 2<sup>nd</sup> Set**

---

2<sup>nd</sup> Set Begin



---

Decimal Value

See Appendix A

---

2<sup>nd</sup> Set Complete



---

**Minimum Length**

---

Minimum Length Begin



---

Decimal Value

See Appendix A

---

Minimum Length Complete



---

## 4.18 Code 93 Parameters

### 4.18.1 Check Digit Transmission

---

Do Not Calculate Check Digit



---

**<Calculate Check 2 Digit and Not Transmit>**



---

### 4.18.2 Setup Code Length

To set the fixed length: (2 sets available)

1. Scan the "Begin" programming code of the desired set
2. Go to the Decimal Value Table in Appendix A. Scan programming codes that represent the length to be read.
3. Scan the "Complete" programming code of the desired set.

Repeat the steps 1 - 3 to set additional length.

---

**<Variable>**



---

**Fixed Length 1<sup>st</sup> Set**

---

1<sup>st</sup> Set Begin



---

Decimal Value

See Appendix A

---

1<sup>st</sup> Set Complete



---

**Fixed Length 2<sup>nd</sup> Set**

---

2<sup>nd</sup> Set Begin



---

Decimal Value

See Appendix A

---

2<sup>nd</sup> Set Complete



---

**Minimum Length**

---

Minimum Length Begin



---

Decimal Value

See Appendix A

---

Minimum Length Complete



## 4.19 Code 11 Parameters

### 4.19.1 Check Digit Transmission

---

<Do Not Calculate Check Digit>	
Calculate Check 1 Digit and Transmit	
Calculate Check 1 Digit and Not Transmit	
Calculate Check 2 Digit and Transmit	
Calculate Check 2 Digit and Not Transmit	

---

### 4.19.2 Setup Code Length

To set the fixed length: (2 sets available)

1. Scan the "Begin" programming code of the desired set
2. Go to the Decimal Value Table in Appendix A. Scan programming codes that represent the length to be read.
3. Scan the "Complete" programming code of the desired set.

Repeat the steps 1 - 3 to set additional length.

---

<Variable>	
------------	---

---

### **Fixed Length 1<sup>st</sup> Set**

---

1<sup>st</sup> Set Begin



Decimal Value

See Appendix A

---

1<sup>st</sup> Set Complete



### **Fixed Length 2<sup>nd</sup> Set**

---

2<sup>nd</sup> Set Begin



Decimal Value

See Appendix A

---

2<sup>nd</sup> Set Complete



### **Minimum Length**

---

Minimum Length Begin



Decimal Value

See Appendix A

---

Minimum Length Complete



## 4.20 MSI/Plessey Code Parameters

### 4.20.1 Check Digit Transmission

---

<Do Not Calculate Check Digit>



---

Calculate Check Digit and Transmit



---

Calculate Check Digit and Not  
Transmit



### 4.20.2 Setup Code Length

To set the fixed length: (2 sets available)

1. Scan the "Begin" programming code of the desired set
2. Go to the Decimal Value Table in Appendix A. Scan programming codes that represent the length to be read.
3. Scan the "Complete" programming code of the desired set.

Repeat the steps 1 - 3 to set additional length.

---

<Variable>



**Fixed Length 1<sup>st</sup> Set**

---

1<sup>st</sup> Set Begin



---

Decimal Value

See Appendix A

---

1<sup>st</sup> Set Complete



---

**Fixed Length 2<sup>nd</sup> Set**

---

2<sup>nd</sup> Set Begin



Decimal Value

See Appendix A

---

2<sup>nd</sup> Set Complete



---

**Minimum Length**

---

Minimum Length Begin



Decimal Value

See Appendix A

---

Minimum Length Complete



## 4.21 Telepen Parameters

### 4.21.1 Type of Code

---

**<Telepen ASCII ON>**



---

Telepen Numeric



### 4.21.2 Check Digit Transmission

---

Do Not Calculate Check Digit



---

Calculate Check Digit and Transmit



---

**<Calculate Check Digit and Not Transmit>**



### 4.21.3 Setup Code Length

To set the fixed length: (2 sets available)

1. Scan the "Begin" programming code of the desired set
2. Go to the Decimal Value Table in Appendix A. Scan programming codes that represent the length to be read.
3. Scan the "Complete" programming code of the desired set.

Repeat the steps 1 - 3 to set additional length.



---

<Variable>



---

**Fixed Length 1<sup>st</sup> Set**

---

1<sup>st</sup> Set Begin



---

Decimal Value

See Appendix A

---

1<sup>st</sup> Set Complete



---

**Fixed Length 2<sup>nd</sup> Set**

---

2<sup>nd</sup> Set Begin



---

Decimal Value

See Appendix A

---

2<sup>nd</sup> Set Complete



---

**Minimum Length**

---

Minimum Length Begin



---

Decimal Value

See Appendix A

---

Minimum Length Complete



## 4.22 GS1 Databar Omnidirectional Parameters

### 4.22.1 Check Digit Transmission

---

**<Calculate Check Digit and Transmit>**



---

Calculate Check Digit and Not Transmit



### 4.22.2 Application ID

---

**<Transmit Application ID>**

Add 01 before GS1 Databar Omnidirectional



---

Do Not Transmit Application ID



### 4.22.3 Symbology ID

---

Transmit Symbology ID  
Add |e0 before GS1 Databar Omnidirectional.



---

**<Do Not Transmit Symbology ID>**



## 4.23 GS1 Databar Limited Parameters

### 4.23.1 Check Digit Transmission

---

<Calculate Check Digit and  
Transmit>



---

Calculate Check Digit and Not  
Transmit



### 4.23.2 Application ID

---

<Transmit Application ID>  
Add 01 before GS1 Databar Limited.



---

Don't Transmit Application ID



### 4.23.3 Symbology ID

---

Transmit Symbology ID  
Add je0 before GS1 Databar Limited.



---

<Don't Transmit Symbology ID>



## 4.24 GS1 Databar Expanded Parameters

### 4.24.1 Symbology ID

---

Transmit Symbology ID  
Add je0 before GS1 Databar  
Expanded.



---

<Don't Transmit Symbology ID>



## **CHAPTER 5 MISCELLANEOUS PARAMETERS**

---

### **5.1 Bar Code ID**

#### **5.1.1 Default Barcode ID**

With this function on, a leading character will be added to the output string while scanning code. User may refer to the following table to know what kind of barcode has been scanned.

Code Type	ID	Code Type	ID
UPC-A	A	UPC-E	B
EAN-8	C	EAN-13	D
Code 39	E	Code 128	F
Interleave 2 of 5	G	Industrial 2 of 5	H
Matrix 2 of 5	I	Codabar/NW7	J
Code 93	K	Code 11	L
China Postage	M	MSI/Plessey	N
Telepen	T	GS1 DataBar Omni.	U
GS1 DataBar Lim.	V	GS1 DataBar Exp.	W

---

Bar Code ID ON



---

<Bar Code ID OFF>



---

Default – Return from User Define  
to Default



---

### 5.1.2 User Define Code ID

To set the code ID

1. Scan the symbologies programming code.
2. Go to the ASCII Table in Appendix B. Scan programming codes that represent the desired ID.

**Note:** User define code ID will override default value. Program will not check the conflict. It is possible to have more than two symbologies which have same code ID.

---

UPC-A



---

UPC-E



---

EAN-13/JAN-13



---

EAN-8/JAN-8



---

CODE 39



---

CODE 128



---

Codabar/NW7



---

Interleave 2 of 5



---

Industrial 2 of 5



---

Matrix 2 of 5



---

CODE 93



---

CODE 11



---

China Postage



---

MSI/PLESSEY



---

Telepen



---

GS1 DataBar Omnidirectional



---

GS1 DataBar Expanded



---

GS1 DataBar Limited



---

## 5.2 Preamble and Postamble Insertion

### 5.2.1 Setup Insertion

To set the insertion of the output characters:

1. Scan the programming code of the desired set.
2. Scan the programming code of the desired symbology
3. Go to the Decimal Value Table in Appendix A. Scan programming codes that represent the desired position to be inserted (1: the first digit, 99: the last digit).
4. Scan the "Complete" programming code of "Character Position to Be Inserted".
5. Go to the ASCII Table in Appendix C, Scan programming codes that represent the desired characters to be inserted.
6. Scan the "Complete" programming code of "Characters to Be Inserted".

Repeat the steps 1 - 6 to set additional insertion.

**Example: Insert \$ as Preamble for Code UPC-A.**

---

Start Configuration



---

1<sup>st</sup> Set





---

Code UPC-A



---

1st Digit



---

Complete



---

\$



---

Complete



---

End Configuration



---

Save Parameters



---

### 5.2.2 Insertion Set Number

---

1<sup>st</sup> Set



---

2<sup>nd</sup> Set



---

3<sup>rd</sup> Set



---

4<sup>th</sup> Set



---

5<sup>th</sup> Set



---

6<sup>th</sup> Set



---

### 5.2.3 Code Type for Insertion

---

UPC-A



---

UPC-E



---

EAN-13/JAN-13



---

EAN-8/JAN-8



---

CODE 39



---

CODE 128



---

Codabar/NW7



---

Interleave 2 of 5



---

Industrial 2 of 5



---

Matrix 2 of 5



---

CODE 93



---

CODE 11



---

China Postage



---

MSI/PLESSEY



---

Telepen



---

GS1 DataBar Omnidirectional



---

GS1 DataBar Expanded



---

GS1 DataBar Limited



---

All Codes



---

None



---

### 5.2.4 Position to Be Inserted

---

Decimal Value

See Appendix A

---

Complete



---

### 5.2.5 Characters to Be Inserted

---

ASCII Table

See Appendix B and C

---

Complete



---

## 5.3 Character Deletion

To setup the deletion of output characters:

1. Scan the programming code of the desired set.
2. Scan the programming code of the desired symbology.
3. Go to the Decimal Value Table in Appendix A. Scan programming codes that represent the desired position to be deleted.
4. Scan the "Complete" programming code of "Character Position to Be Deleted".
5. Go to the Decimal Value Table in Appendix A. Scan programming codes that represent the number of characters to be deleted.
6. Scan the "Complete" programming code of "Number of Characters to Be Deleted".

Repeat the steps 1 - 6 to set additional deletion.

**Example: Delete first 3 digits Code EAN-13.**

---

Start Configuration	
1 <sup>st</sup> Set	
Code EAN-13	
1st Digit - Delete from the 1 <sup>st</sup> digit	
Complete	
3 - Delete 3 digits	
Complete	
End Configuration	
Save Parameters	

---

### 5.3.1 Deletion Set Number

1 <sup>st</sup> Set	
2 <sup>nd</sup> Set	
3 <sup>rd</sup> Set	
4 <sup>th</sup> Set	
5 <sup>th</sup> Set	
6 <sup>th</sup> Set	

### 5.3.2 Code Type for Deletion

UPC-A	
UPC-E	
EAN-13/JAN-13	
EAN-8/JAN-8	

---

CODE 39



---

CODE 128



---

Codabar/NW7



---

Interleave 2 of 5



---

Industrial 2 of 5



---

Matrix 2 of 5



---

CODE 93



---

CODE 11



---

China Postage



---

MSI/PLESSEY



---

Telepen



GS1 DataBar Omnidirectional	
GS1 DataBar Expanded	
GS1 DataBar Limited	
All Codes	
None	

### 5.3.3 Position to Be Deleted

Decimal Value	See Appendix A
Complete	

### 5.3.4 Number of Characters to Be Deleted











Decimal Value	See Appendix A
Complete	













## APPENDIXES

---

### A. Decimal Value Table

 0	 1
 2	 3
 4	 5
 6	 7
 8	 9

## B. ASCII Value Table

 0	 1
 2	 3
 4	 5
 6	 7
 8	 9
 Enter	























## C. ASCII Table

















NULL		SOH	
STX		ETX	
EOT		ENQ	
ACK		BEL	
BS		HT	
LF		VT	
FF		CR	
SO		SI	
DLE		DC1	
DC2		DC3	

DC4		NAK	
SYN		ETB	
CAN		EM	
SUB		ESC	
FS		GS	
RS		US	
SPACE		!	
"		#	
\$		%	
&		'	
(		)	

*		+	
, Comma		- Minus	
. Period		/	
0 Number Zero		1 Number One	
2		3	
4		5	
6		7	
8		9	
:		;	
< Less Than		=	
> Greater Than		?	

@		A	
B		C	
D		E	
F		G	
H		I Letter I	
J		K	
L		M	
N		O Letter O	
P		Q	
R		S	
T		U	

V		W	
X		Y	
Z		[	
\		]	
^		<u>    </u> Underscore	
`		a	
b		c	
d		e	
f		g	
h		i	
j		k	

l		m	
n		o	
p		q	
r		s	
t		u	
v		w	
x		y	
z		{	
 Vertical Slash		}	
~		DEL	



## D. Function Key Table

<b>F1</b>		<b>F7</b>	
<b>F2</b>		<b>F8</b>	
<b>F3</b>		<b>F9</b>	
<b>F4</b>		<b>F10</b>	
<b>F5</b>		<b>F11</b>	
<b>F6</b>		<b>F12</b>	
<b>Insert</b>		<b>Delete</b>	
<b>Home</b>		<b>End</b>	
<b>Page Up</b>		<b>Page Down</b>	
<b>Left</b>		<b>Right</b>	

<b>Up</b>		<b>Down</b>	
-----------	---	-------------	---

## **E. Technical Specifications**

### **Physical Characteristics: Scanner**

Scanner Weight	Approx. 215g (include batteries)
Charger Weight	Approx. 135g (include adaptor)
Material	ABS Plastic
Dimension	82.9 mm(L) x 75.0 mm(W) x 171.3 mm(H)

### **Physical Characteristics: Bluetooth Cradle**

Weight	Approx 150 g
Material	ABS Plastic
Connector	RJ 45C 10Pins
Dimension	130.6 mm(L) x 112.2 mm(W) x 84.6 mm(H)

### **Operational**

Light Source	Visible Red light 632nm LED
Sensor	Linear CCD Sensor
Processor Type	ARM Cortex™-M3, 32-bit
Operating Freq.	8 MHz
Scan Speed	Smart detection up to maximum 500 scans/sec
Depth of Field	Up to 500mm@20mil/0.5mm, PCS90%, Code39
Print Contrast Ratio	PCS45%@5mil/0.127mm
Minimum Resolution	4mil/0.1mm@PCS90%,Code39
Reading Angle	Test Conditions:PCS90% Code 39, 10mil/0.25mm
Pitch Angle	±5°~60° (±5°)
Skew Angle	±5°~60° (±5°)

## Electrical Characteristics

### Scanner:

Voltage Battery	Li-Ion 3.7V/2600 mAh
Charge Time	5.5 hours
Reads per Charge	20,000 Times
Scanner LED Indicator	
Good read	Green
Error / Alarm	Red
Bluetooth Communication	Blue
Power Consumption	
Power On	400mA
Stand by	270mA
Operation	290mA
Sleep	36mA

### Cradle:

Voltage	5 VDC@2A / Input AC 110-240V
Cradle LED Indicator	
Good read	Green
Transmitted Success	Blue
Power Consumption	
Power On	95mA
Stand by	55mA
Operation	70mA

## Radio Characteristics

Bluetooth Module	Bluetooth V2.0 Standard
Frequency Band	2.402GHz ~ 2.480GHz
Modulation Method	GFSK for 1Mbps
RF Output Power	Class 1 (under 20dBm)
Transmission Range	Up to 80m(266.67ft) line of sight

## Environmental

Operating Temp.	0°C to 50°C (32°F to 122°F)
Storage Temp.	-20°C to 70°C (-4°F to 158°F)
Relative Humidity	20 to 95% non-condensing
Ambient Light Immunity	10,000 LUX max @ Direct sun Light
Ingress Protection	Sealed with IP42 rating protection
Scanner Drop Specification	Functions normally after repeated 1.2m(4ft) drops to concrete surface
Sealing	IP42

## Regulatory of Compliance

FCC  
CE

## F. Scan Map

### Typical Reading Distance

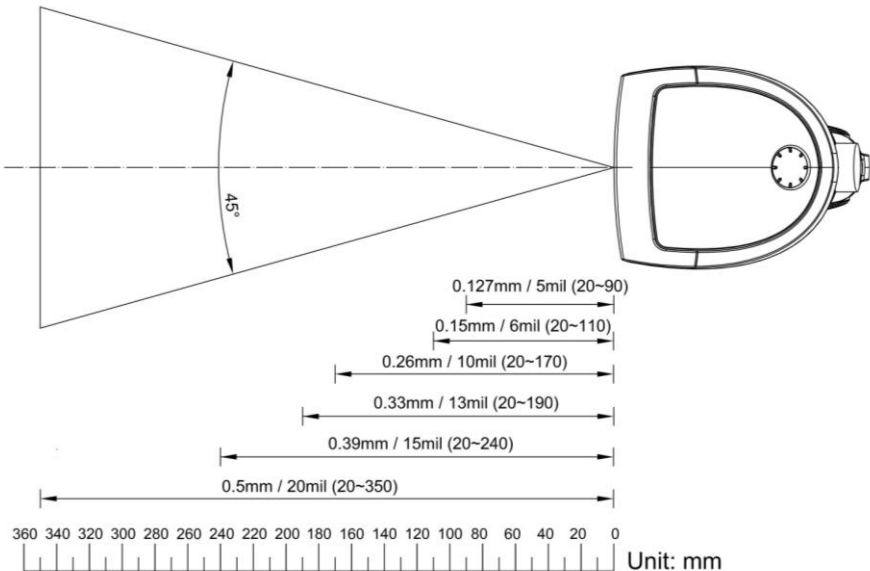

## G. LED Indicator Status

Status	Scanner Indicators	
	LED	Buzzer
Power On	Green Light and Buzzer Simultaneously	Be-Be-Be* 2 loops
Battery No Power	Red Blink 3 times	Bi-Bi-Bi
Battery Low Power Alarm	Red Blink 1 time	Be per 20 seconds
Battery Very Low Power Alarm	Red Blink 4 times	Bi-Bi-Bi-Bi per 10 seconds
Memory Full	Red Blink 2 times	Be-Be
Transmitted Succeed or save on memory	Green Blink 1 time	Be
Transmitted Fail	Red Blink 2 times	Bi-Bi
Configure Setup	Green Light and Buzzer Simultaneously	Bi-Bi-Bi
BT Connecting Build	Blue Blink 2 times per second	N/A
BT Connecting Succeed	Blue light 2 second	Up-Tone
BT Connected	Blue Blink per Second	N/A
BT Disconnect	Blue Light 2 Second	Down-Tone
Charging	Red Light Continue	N/A
Full Charge	Green Light Continue	N/A
Enter Sleep	N/A	Down-Tone







Remarks: 'Be' means Long Beep, 'Bi' means short beep.





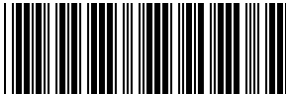







Status	Cradle Indicators	
	LED	Buzzer
Power On	Red Light Continue	N/A
Transmitted Succeed	Green Blink 1 Time	N/A
BT Connected	Blue Blink Continue	N/A
BT Disconnect	Blue Blink 2 Times per Second	N/A

## H. Test Symbologies

Scan one or more of these bar codes to test symbologies you enabled.

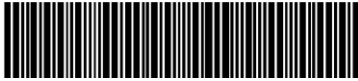
### 1D Symbology

Codabar/NW7 	CODE 11 
CODE 39 	CODE 93 
CODE 128 	EAN 8 

<p>EAN 13</p> 	<p>Interleave 2 of 5</p> 
<p>ISBN</p> 	<p>ISSN</p> 
<p>GS1 DataBar Omnidirectional</p> 	<p>GS1 DataBar Expanded</p> 
<p>GS1 Databar Limited</p> 	<p>MSI / Plessey</p> 
<p>Matrix 2 of 5</p> 	<p>Industrial 2 of 5</p> 
<p>UPC A</p> 	<p>UPC E</p> 
<p>Telepen</p> 	<p>China Postage</p> 

## QUICK CONFIGURATION

Start Configuration



(Select your Settings)

End Configuration



Save Parameters



Set All Defaults



Recall Stored Parameters



Abort Configuration



Version Information

