

# SPECIFICATION

Customer : \_\_\_\_\_

Customer's Model No. : \_\_\_\_\_

Model No. : **SD320**

Contact to middle range barcode scanner Series

Sample Serial No. : \_\_\_\_\_

Spec. Version & Revision Date: V02 2013.12.15

Received/Approved by

The logo for CHAMPTEK features the word "CHAMPTEK" in a bold, italicized, sans-serif font. A red checkmark is positioned over the letter "A".

Http://www.champtek.com

E-mail : [sales@champtek.com](mailto:sales@champtek.com)

ChampTek Incorporated

5/F, No. 2, Alley 2, Shih-Wei Lane, Chung Cheng Rd.,  
Xindian District, New Taipei City 231, Taiwan

TEL : 886-2-22192385

FAX : 886-2-22192387

Revision History

Version	Date	Context
V01	2013.07.05	Golden release
V02	2013.12.15	Update drawing of keyboard wedge cable

## TABLE OF CONTENTS

A. General Description.....	4
B. Physical Characteristics.....	2
C. Electrical Characteristics.....	4
D. Performance.....	5
E. Environmental .....	5
F. Readable Symbologies .....	6
G. Pin Assignment.....	7
H. Reliability .....	9
I. Packing .....	10

## A. General Description

This well-designed handheld contact type linear imager scanner has inherited the characteristic of “high performance with low price” from its previous series. Aside from the principle of excellence mechanical design, it also installs with many user-friendly operations; detachable cable, 4-in-1 interface, and 2 years product warranty; these have added-up additional values to it.

As far as the performance, this scanner provides reliable scanning depth from contact to 50mm, Collaborating with POS or regular cash register system, user is able to program this device to “continuous mode ” or any other scan mode if needed,

Aid in various major barcodes, hand-on software-programming function, this economical-type barcode scanner is the best choice ever.



## B. Physical Characteristics

### Weight

Body weight                      Approx. 130g/ 4.58oz (w/o cable)

Material                              ABS & Rubber

Connector                            RJ 45C 10Pins

Dimension                            90mm W x 56.2mm H x 173.5 mm L

Color Available                      Beige or Black

### 1) Mechanical drawing

(Unit: mm)

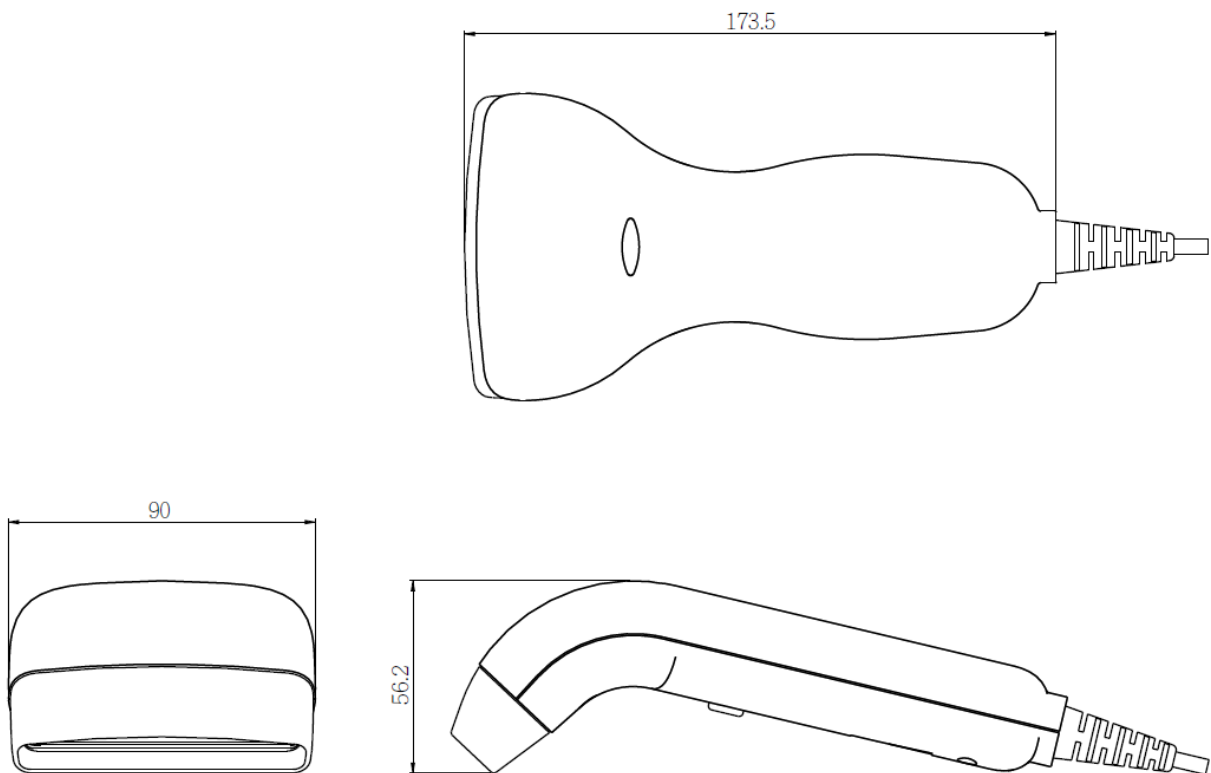

**2) Cable drawing**  
**a.KBW Interface**

UNIT:mm

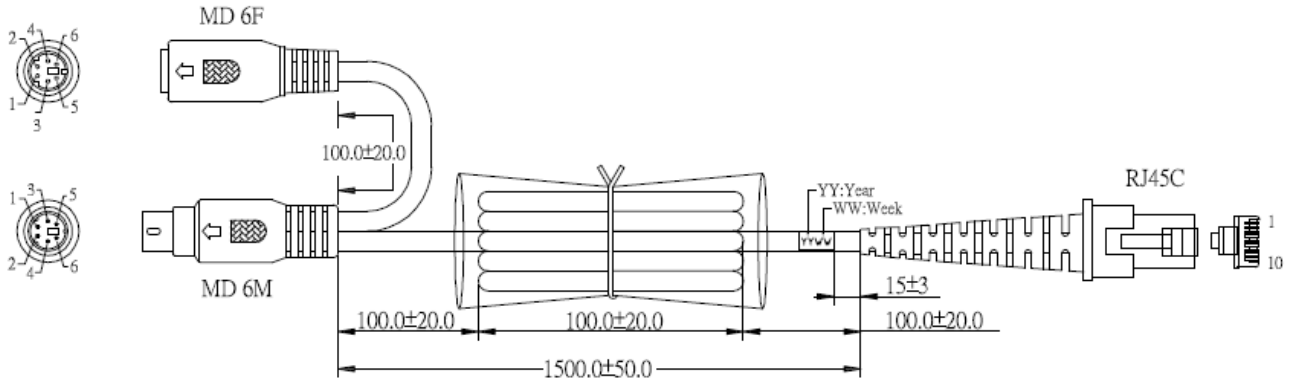

MD 6F	MD 6M	RJ45C	FUNCTION	COLOR
	1	2	HOST DATA	Green
3	3	3	GND	Brown
	5	4	HOST CLK	Blue
4	4	5	VCC	Red
5		6	KB CLK	Orange
1		8	KB DATA	Yellow
Spiral	Shell	Shell	SHELDING	

**b.RS232 Interface**

UNIT:mm

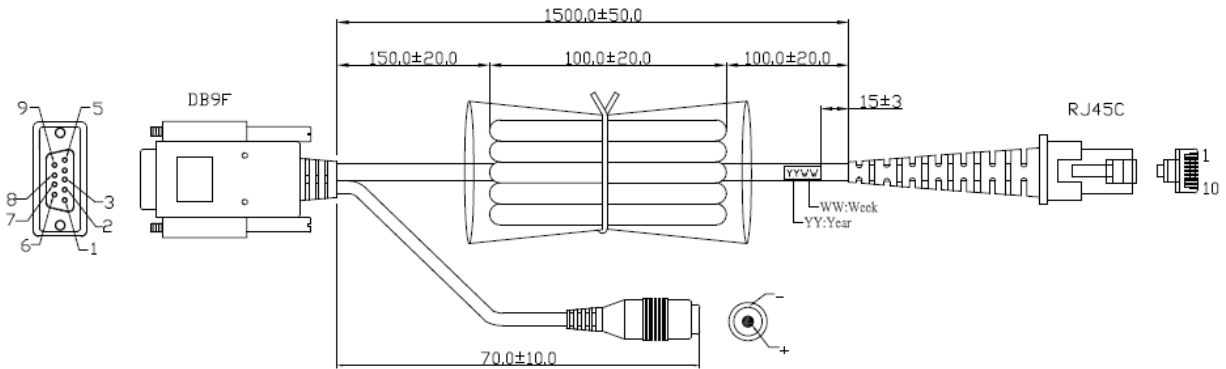

DB9F	RJ45C	DC JACK	FUNCTION	COLOR
5	3	Shell	GND	Brown
9	5	CORE	DC +5V±5%	Red
2	7		TXD	Orange
3	9		RXD	Yellow
8	1		RTS	Green
7	10		CTS	Blue
Shell			Spiral	

**c.USB Interface**

UNIT:mm

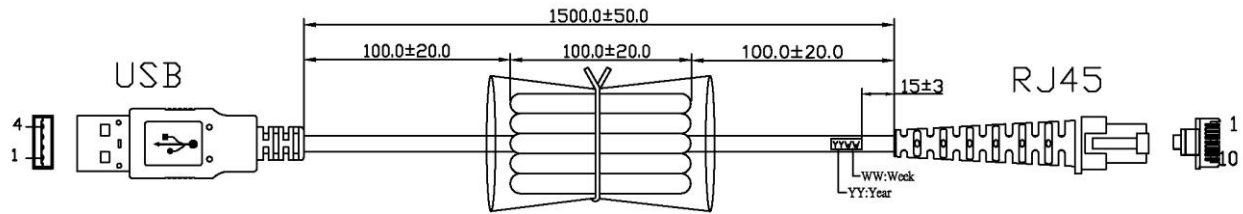

USB	RJ45	FUNCTION	COLOR
1	5	VCC	Red
2	4	D-	Bluc
3	2	D+	Green
4	3	GND	Brown
Shell	3	SHIELDING	

**C. Electrical Characteristics**

Interface	RS232	KB	USB
Supply Voltage	DC +5V±5%	DC +5V±5%	DC +5V±5%
Current Draw	±10% , is applicable to all interfaces.		
Power On (Typ.)	155 mA	153 mA	153 mA
Stand by (Typ.)	72 mA	71 mA	71 mA
Operation (Typ.)	124 mA	120 mA	122 mA

## D. Performance

Light Source	Visible Red Light 32nm LED
Processor Type	32 bits
Operating Freq.	8 MHz
Scan Rate	120 scans per second $\pm 10\%$
Reading Distance	Up to 50mm@20mil/0.5mm, PCS90%
Width of Field	80mm at window, 90mm at 50mm depth
Print Contrast Ratio	30%
Resolution	4mil/0.1mm@ PCS90%, Code39
Reading Angle	<i>Test Conditions : Code 39, 10mil/0.25mm, PCS 90%</i>
Forward (Front)	$3^{\circ}\sim 45^{\circ}(\pm 5^{\circ})$
Left & Right	$\pm 25^{\circ}(\pm 5^{\circ})$
Ambient Light	
Fluorescent lamp	5,000 Lux Max.
Direct sun light	3,000 Lux Max.
Indicator	Beep and LED (Good read Green)

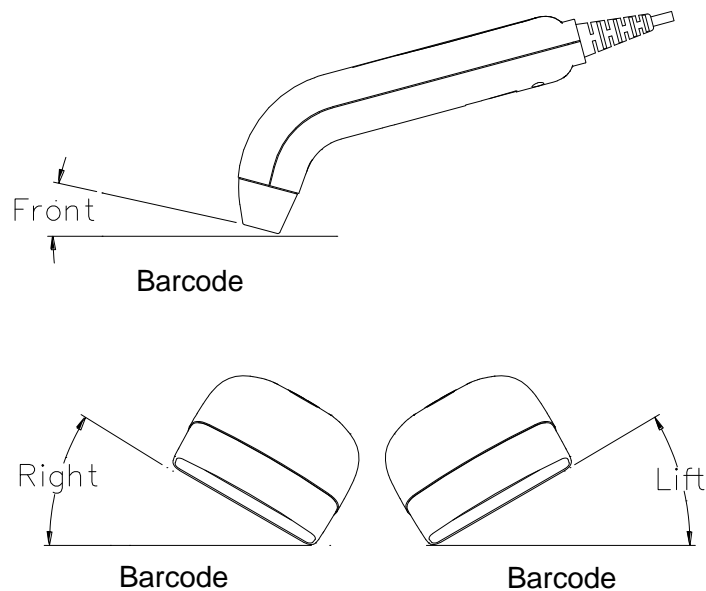

## E. Environmental

Operating Temperature	0 °C to 50 °C (32 °F to 122 °F)
Storage Temperature	-20 °C to 70 °C (-4 °F to 158 °F)
Relative Humidity	20% to 95% (Non-condensing)



## F. Readable Symbologies

	Readable	Default Enable
All UPC/EAN/JAN	V	V
EAN128 Code	V	
Code 39	V	V
Code 39 Full ASCII	V	
Code32 / Italian Pharmacy	V	
Code 128	V	V
CODABAR/NW7	V	V
Interleave 25	V	V
Industrial 25	V	
Matrix 25	V	
MSI/PLESSEY	V	
Telepen	V	
Code 93	V	
Code 11	V	
China Postage	V	
Code 26	V	
LCD25	V	
GS1 DataBar Omnidirectional & Stacked	V	
GS1 DataBar Limited	V	
GS1 DataBar Expanded & Stacked	V	

## G. Pin Assignment

### a) Keyboard Interface

#### MiniDIN 6 MALE

Pin No.	Function
1	HOST DATA
3	GND
4	Vcc(+5V±5%)
5	HOST CLK

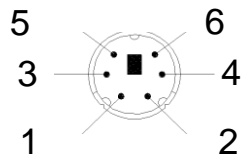

#### MiniDIN 6 FEMALE

Pin No.	Function
1	KB DATA
3	GND
4	Vcc(+5V±5%)
5	KB CLK

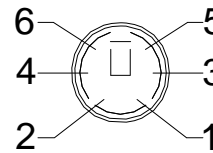

### b) RS-232 Interface

#### DB 9 Female

Pin No.	Function
2	TXD
3	RXD
5	GND
7	CTS
8	RTS
9	Vcc/+5V±5%
Power Lead	Vcc/+5V±5%

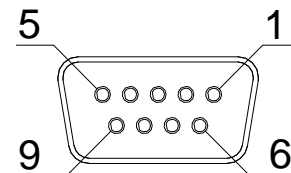

**c) WAND Emulation Interface**

**DB 9 Female**

Pin No.	Function
2	DATA
7	GND
9	V <sub>CC</sub> /+5V±5%

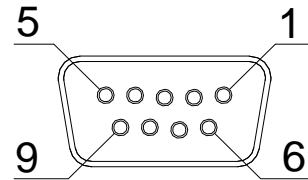

**d) USB Interface**

**USB A Type Male**

Pin No.	Function
1	V <sub>CC</sub> /+5V±5%
2	D-
3	D+
4	GND

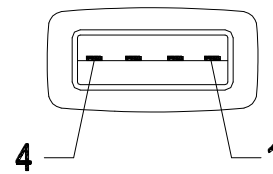

**Decoder Data Output**

Type	RJ45 10P
Pin No.	Function
1	RTS
2	HOST DATA
3	GND
4	HOST CLK
5	V <sub>CC</sub> (+5V±5%)
6	KB CLK
7	TXD
8	KB DATA
9	RXD
10	CTS

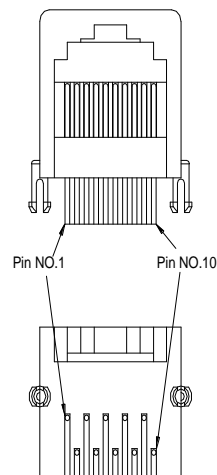

## H. Reliability

### Life Time

Trigger Switch	1,000,000 times
MTBF(Calculated)	50,000 hours

### Thermal Shock

High Temp.	60 °C (140 °F)
Low Temp.	-20 °C (-4 °F)
Cycle time	30 minutes for high temp. , 30 minutes for low temp.
Cycles	24 cycles

### Cable Bending Test

Drop	47.24 inches (120cm) drop on concrete surface
------	---

## I. Packing

### Dimension

Unit	24X9.8X7cm
Carton	42X38X26.5cm

### Storage

Temperature	-20 °C to 60 °C (-4 °F to 140 °F)
Humidity	20% to 95% (Non-condensing)

### Unit :

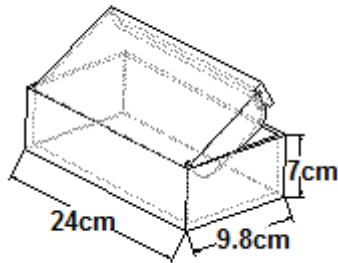

### Carton :

