

# SPECIFICATION

Customer: \_\_\_\_\_

Customer's Model No.: \_\_\_\_\_

Model No.: **LIBRA L-7082i** Area Imager Barcode Scanner \_\_\_\_\_

Date: \_\_\_\_\_

Sample Serial No.: \_\_\_\_\_

Spec. Version & Revision Date: \_\_\_\_\_

**Rev V00** 2017.10.31

Received/Approved by

**CHAMPTEK**<sup>®</sup>  
阿丹電子企業股份有限公司

Web : <http://www.champtek.com>

E-mail : [sales@champtek.com](mailto:sales@champtek.com)

**Champtek Incorporated**

5/F, No. 2, Alley 2, Shih-Wei Lane, Chung Cheng Rd.,  
Hsin Tien District, New Taipei City, Taiwan, R.O.C.

Tel : 886-2-22192385

Fax : 886-2-22192387

## Revision History

Version	Date	Context
V00	2017.10.31	Released

## TABLE OF CONTENTS

A. General Description .....	4
B. Physical Characteristics .....	5
C. Connecting.....	6
D. Powering.....	6
E. Electrical Characteristics (check) .....	7
F. Performance .....	7
G. Environmental.....	8
H. Reading Range.....	8
I. Readable Symbologies .....	9
J. Reliability .....	10

## A. General Description

The LIBRA L-7082i is a high performance, omni-directional area imager bar code scanner. It uses digital imaging technology to provide intuitive and fast reading of 1D and 2D bar codes as well as supporting more advanced features like image capture deactivation. It is designed for various OEM solutions, on-counter reading options.

It supports up to 300mm reading depth of 1D and 2D barcode, its scan rate is up to 60 images per second in 1D/2D area mode. Based on CMOS technology for optimal image sensitivity and dynamic range, the L-7082li features scanning speeds faster than traditional 2D imagers.

LIBRA L-7082i is a high performance area imager scanner, provides customers with the most cost-effective solution in the market and perfectly suitable and definitely the best choice for any retail and logistic environment.



## B. Physical Characteristics

Weight	
Body weight	Approx.378g
RS232 Cable weight	Approx.123g
USB Cable weight	Approx. 67g
Material	ABS Plastic
Connector	RJ 48C 10 Pin
Dimension(WxDxH)	94 x 97.71 x 161.51 mm
Color Available	Black/Gray

### Body Dimension

Unit: mm

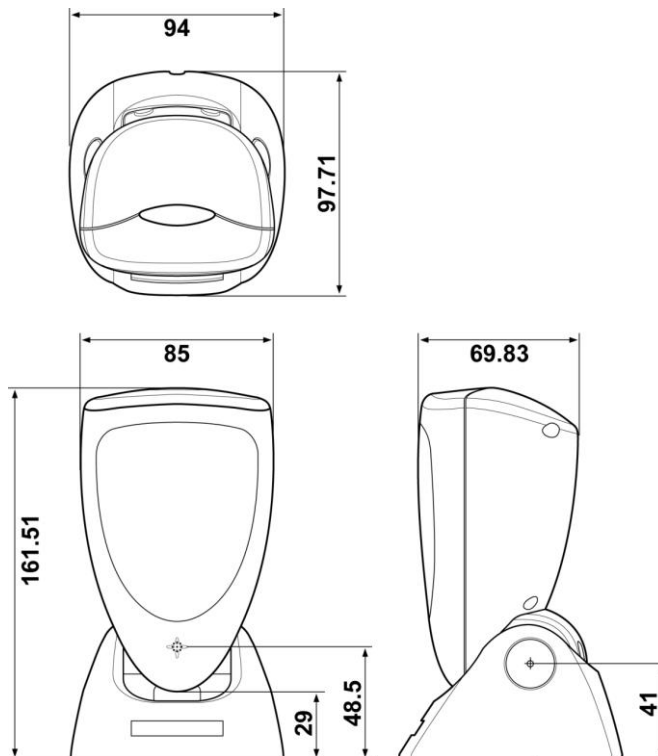





## C. Connecting

### Interface Selection

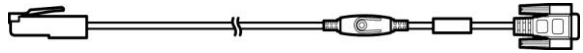
LIBRA L-7082i allows you to connect your host system using two different interface cables, RS232 or USB.

On powering up, the scanner determines the type of the interface used and switches to the appropriate protocol.

Interface Cable	Connector type
<b>RS232</b> (Product Number: 0114-SM01121) 	Sub-D 9-pin 
<b>USB</b> (Product Number: 0114-S802131) 	USB connector 

## D. Powering

L-7082i power is designed by USB+5V, do not need power supply once the interface is USB, but will request power supply for RS232 interface.

### Power injector

RS232 cable has a power injector to connect an external power supply.

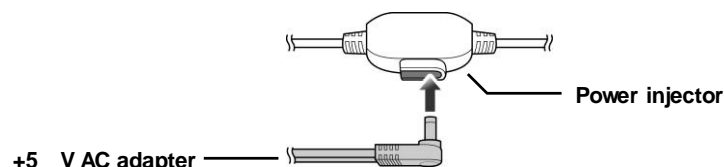

Cable	Power injector
RS232	√
USB	×

## E. Electrical Characteristics (check)

Interface	RS232	USB
Supply Voltage	DC Adaptor +5V $\pm$ 5%	USB Power
Stand-by (Typ.)	180 mA	180 mA
Operation (Typ.)	360 mA	360 mA

## F. Performance

Light source	Visible red light 625nm $\pm$ 5nm LED
View of filed	Horizontal – 40°, Vertical – 25°
Depth of field	Refer to “Reading Range” Session
Resolution	752 (H) x 480 (V) pixels 5.0 mil (Code 39), 10 mil (PDF417)
Scan speed	up to 120 scans per second in linear emulation and 60 images per second in 2D area mode
Pitch	$\pm$ 60°(from front to back)
Skew	$\pm$ 60°(from plane parallel to symbol(side- to-side))
Roll	360°
Interface	RS-232 or USB
Indicators	Beep and LED (Standby Orange, Good read Blue)

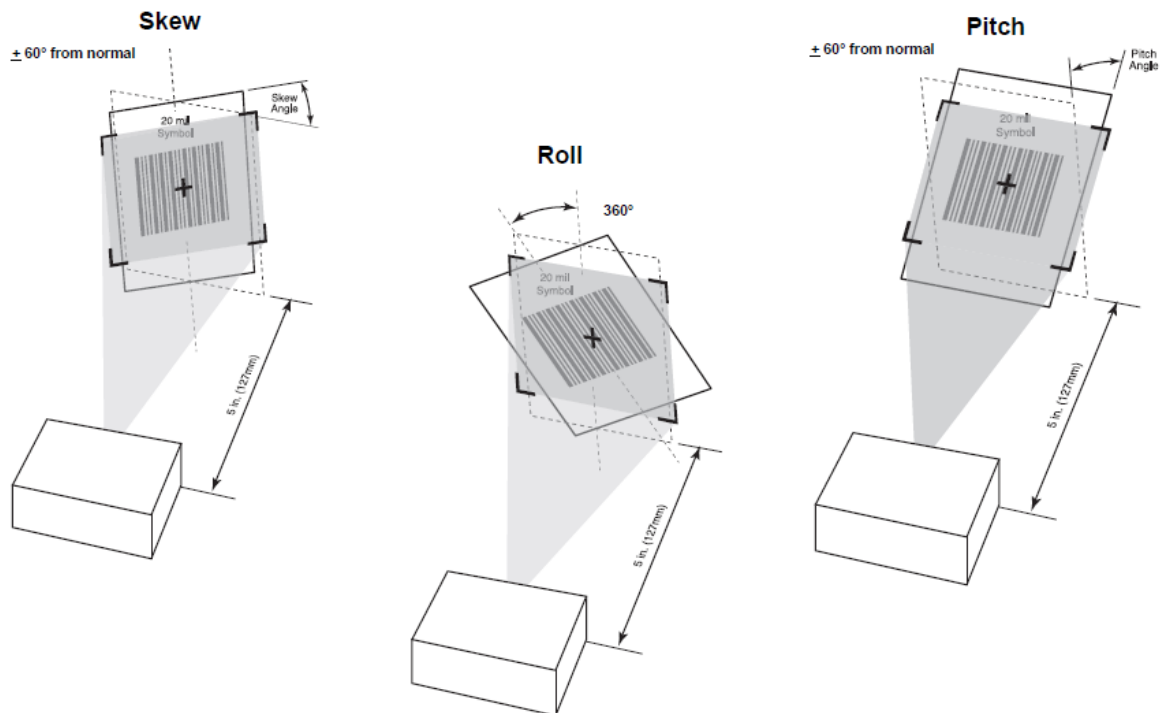

## G. Environmental

Operating Temp.	0°C to 50°C (32°F to 122°F)
Storage Temp.	-20°C to 70°C (-4°F to 158°F)
Relative Humidity	20% to 95% (Non-condensing)
Ambient light	100,000 Lux Max. (Sunlight)
Sealing	Designed to IP42 water and dust protection

## H. Reading Range

The following table summarizes the reading distance for the specified codes with both the wide area field and the high density field enabled and active for decoding.

Barcode	Depth of field
4mil Code39	25~ 50 mm
5mil Code39	28~85 mm
10mil Code39	15~120 mm
20mil Code39	20~210 mm
20mil QR Code	40~180 mm
10mil PDF417	0~140 mm
20mil PDF417	25~220 mm
20mil Data Matrix	0~170 mm

Note 1: Near distance is Field of View (FOV) limited by barcode's size.



## I. Readable Symbolologies

<b>1D Symbolologies</b>	<b>Readable</b>	<b>Default Enable</b>
UPC-A	V	V
UPC-E	V	V
EAN-8/JAN-8	V	V
EAN-13/JAN-13	V	V
Code 39	V	V
Code 128	V	V
Interleaved 25	V	
Industrial 25	V	
Matrix 25	V	
Codabar/NW7	V	
Code 93	V	
China Post	V	
MSI/Plessey	V	
Telepen	V	
GS1 Databar Omni-directional	V	
GS1 Databar Limited	V	
GS1 Databar Expanded	V	

<b>2D Symbolologies</b>	<b>Readable</b>	<b>Default Enable</b>
Aztec	V	
Aztec Mesas	Optional	
Data Matrix	V	V
Maxi Code	Optional	
PDF 417	V	V
Micro PDF 417	V	
QR Code	V	V
Micro QR Code	Optional	
GM Code	Optional	
Han Xin Code	Optional	

## J. Reliability

### Life Time

MTBF(Calculated) 50,000 hours

### Temp. Test

High Temp. 70°C; 48 H

Low Temp. -20°C; 48H

Cable Bending Test 25,000 times minimum (30 times/min @ 500g/90°)

Drop Resistance 39.38 inches(100cm) drop on concrete surface